

Estradiol and dihydrotestosterone regulate endothelial cell barrier function after hypergravity-induced alterations in MAPK activity

Wasana K. Sumanasekera,¹ Gamini U. Sumanasekera,² Kathleen A. Mattingly,¹ Susan M. Dougherty,¹ Robert S. Keynton,³ and Carolyn M. Klinge¹

¹Department of Biochemistry and Molecular Biology and Center for Genetics and Molecular Medicine, School of Medicine, ²Department of Physics, and ³Department of Bioengineering, Speed School of Engineering, University of Louisville, Louisville, Kentucky

Submitted 4 August 2006; accepted in final form 8 March 2007

Sumanasekera WK, Sumanasekera GU, Mattingly KA, Dougherty SM, Keynton RS, Klinge CM. Estradiol and dihydrotestosterone regulate endothelial cell barrier function after hypergravity-induced alterations in MAPK activity. *Am J Physiol Cell Physiol* 293: C566–C573, 2007. First published March 14, 2007; doi:10.1152/ajpcell.00418.2006.—Postflight orthostatic intolerance (POI) was reported to be higher in female than male astronauts and may result from sex-dependent differences in endothelial cell (EC) barrier permeability. Here the effect of 17 β -estradiol (E₂) and dihydrotestosterone (DHT) on the expression of the tight junction protein occludin, EC barrier function, and MAPK activation over time was tested after subjecting human umbilical vein EC (HUVEC) to brief hypergravity identical to that experienced by astronauts during liftoff (LO) into space. After LO hypergravity, HUVEC showed a time-dependent decrease in occludin correlating with an increase in paracellular permeability and a decrease in transendothelial electrical resistance, indicating a decrease in EC barrier function. LO hypergravity inhibited MAPK activation, which remained suppressed 4 h after LO. Inhibition of MAPK activation correlated with decreased phosphotyrosine occludin, decreased cytochrome-*c* oxidase activity, and increased paracellular permeability, suggesting a mechanism by which LO hypergravity decreased EC barrier function. Time-dependent differences in MAPK activation, decreased occludin, and EC barrier function between HUVEC treated with E₂ vs. DHT were observed. HUVEC showed delayed activation of MAPK with DHT, i.e., 4 h rather than 2 h for E₂, which correlated with decreased paracellular permeability and the observed sex differences in POI in astronauts. These data temporally separate E₂ and DHT effects in HUVEC and provide evidence for the possible protective roles of sex steroids on EC function after brief exposure to low hypergravity.

paracellular permeability; estrogen; androgen

AFTER RETURNING from spaceflight, ~24–65% of astronauts experience symptoms including lightheadedness, loss of peripheral vision, or a sudden drop in systolic blood pressure when they are subjected to orthostatic challenges (12). A study of a small group ($n = 35$) of astronauts suggested that post-flight orthostatic intolerance (POI) is sex related since women had a higher incidence of POI compared with men (50). Because female astronauts are premenopausal, sex steroid hormones may play a role in the observed sex differences in POI (44).

Symptoms of POI may result from fluid leakage through the endothelial cell (EC) tight junction (TJ) barrier (22). TJ prevent

the paracellular route of solute transport between EC by creating a physiological barrier that is regulated and maintained by TJ proteins including occludin, claudins, and zonula occludens (ZO)-1, -2, and -3 (51). In human umbilical vein EC (HUVEC), activation of ERK/MAPK, an indicator of cell survival (30, 37), has been shown to phosphorylate occludin, resulting in increased paracellular permeability by altering the intracellular and plasma membrane distribution of occludin (28). Likewise, in human corneal epithelial cells MAPK-mediated phosphorylation of occludin resulted in disintegration of TJ (49). However, the impact of occludin phosphorylation is cell type specific. For example, in canine renal epithelial cells [Madin-Darby canine kidney (MDCK) cells] phospho (P)-occludin localizes at TJ (18, 39) and tyrosine phosphorylation of occludin was reported to decrease paracellular permeability (9, 47).

We previously investigated (44) the effect of subjecting HUVEC to a brief (7.5-min) hypergravity profile (up to 3 g), mimicking liftoff (LO) of the space shuttle from Earth into orbit, to determine whether LO hypergravity alters EC function including occludin expression and MAPK signaling. In that study, it was postulated that POI may be caused by a loss of TJ function following LO hypergravity; however, it was demonstrated that LO did not affect occludin expression measured immediately after exposure to LO hypergravity (44).

Systemic cardiovascular responses to gravity include changes in cardiac output, blood pressure, and shear stress and many cell signaling events resulting in changes in vascular tone and fluid balance and a variety of alterations in cell signaling (14–16). One limitation of using HUVEC as a model to evaluate responses to LO hypergravity is that HUVEC are from a conduit fetal vessel, not from adult microvascular beds. However, HUVEC serve as a convenient model to study the effect of hypergravity in EC.

The role of sex hormones in regulating EC paracellular permeability has not been defined. Both estrogens and androgens activate target gene transcription by binding to their respective nuclear receptors (genomic action) as well as by binding to receptors associated with the cell membrane (nongenomic action) (reviewed in Ref. 29). Rapid, nongenomic effects of 17 β -estradiol (E₂) (8) and dihydrotestosterone (DHT) (4) include activation of the MAPK and phosphatidylinositol 3-kinase (PI3K) signaling pathways. E₂ regulates occludin by both genomic and nongenomic mechanisms in hu-

Address for reprint requests and other correspondence: C. M. Klinge, Dept. of Biochemistry and Molecular Biology and Center for Genetics and Molecular Medicine, School of Medicine, Univ. of Louisville, KY 40292 (e-mail: carolyn.klinge@louisville.edu).

The costs of publication of this article were defrayed in part by the payment of page charges. The article must therefore be hereby marked “advertisement” in accordance with 18 U.S.C. Section 1734 solely to indicate this fact.

man vascular EC (51). We reported (44) that 24-h pretreatment of HUVEC with 10 nM E₂ or 10 nM DHT increased occludin expression and that LO hypergravity did not alter the induced occludin levels. Furthermore, neither E₂ nor DHT prevented the LO-mediated decrease in MAPK activation immediately following LO hypergravity (44). With the exception of this previous study, no one has examined the effect of DHT or other androgens on EC paracellular permeability or occludin expression. Because occludin is important in maintaining the EC barrier, researchers have reported data supporting a role for occludin in maintaining the EC TJ barrier (44). An important goal of the present study was to determine the effect of sex steroids and hypergravity on paracellular permeability and transendothelial electrical resistance (TEER) across the EC barrier as a functional measure of EC response to LO hypergravity. In addition, the question of whether MAPK activity and occludin expression change over time when HUVEC are returned to 1 g after LO hypergravity is applied was investigated. Specifically, this study investigated whether HUVEC treated with E₂ or DHT show a time- and/or hormone-dependent recovery from LO suppression of MAPK activity and changes in occludin expression and/or phosphorylation and paracellular permeability when restored to 1 g.

MATERIALS AND METHODS

Materials. E₂ and DHT were purchased from Sigma (St. Louis, MO). Bicalutamide (Casodex) was graciously provided by AstraZeneca (Alderley Park, UK). PD-98059 (a MEK1 inhibitor) was purchased from Cell Signaling Technology (Beverly, MA). Antibodies for p44/42 MAPK (ERK1/2) and phospho-p44/42 (Thr202/Tyr204) MAPK (P-ERK1/2) were purchased from Cell Signaling Technology. β -Actin and occludin antibodies were purchased from Sigma and Zymed Laboratories (San Francisco, CA), respectively. Super Signal West Pico Chemiluminescent Substrate and protease and phosphatase inhibitors were purchased from Pierce (Rockford, IL) and Sigma, respectively. Mouse anti-phosphotyrosine antibody was purchased from BD Biosciences Pharmingen (San Jose, CA).

Cell culture. HUVEC (pooled from male and female tissues) were purchased from Cambrex BioScience (Walkersville, MD) and cultured in EGM-2 growth medium that consisted of EBM-2 supplemented with growth factors (GF) and 2% fetal bovine serum (FBS) (all supplied with the EGM-2 medium in a kit from Cambrex BioScience) in 5% CO₂ at 37°C. HUVEC were used between passages 3 and 8. For hormone treatments, HUVEC were cultured in EBM-2 without GF and without serum for 24 h before addition of E₂ and DHT to that medium, i.e., no GF or serum. For LO hypergravity experiments, cells were grown to 80–90% confluence in BD Falcon T-75 flasks. On the day of the LO experiment, the serum-free medium was removed and replaced with 250 ml of RPMI medium (GIBCO-Invitrogen, Grand Island, NY) supplemented with vehicle (EtOH) or the hormone indicated in Figs. 1–6.

Hypergravity experiments. Cells were placed in a tabletop 37°C incubator/centrifuge [National Aeronautics and Space Administration (NASA) Flight Simulator, SHOT centrifuge] specifically designed to hold BD Falcon T-75 flasks (SHOT, New Albany, IN) (44). The hypergravity experiments were performed as described previously (44). In brief, the cells were subjected to short-term LO hypergravity, which was simulated with a 7.5-min computer algorithm linked to the centrifuge to generate the exact g force profile (previously reported in Ref. 44) experienced by astronauts during LO of the NASA space shuttle. The temperature inside the SHOT centrifuge was maintained at 37°C, and the hypergravity changes were automatically simulated with appropriate speed changes of the centrifuge as regulated by the computer controller and the operator using a computer program on a

desktop computer. After completion of the LO hypergravity run, cells were placed in a 37°C 5% CO₂ tissue culture incubator at 1 g for the time period indicated in Figs. 1, 2, 4, 5, and 6. HUVEC were harvested as previously described (44). Protein concentrations in the whole cell lysates (whole cell extracts, WCE) were determined by Bio-Rad assay.

Western blotting. Western blotting was performed as described previously (44). In brief, 40–50 μ g of protein was separated on 10% polyacrylamide SDS gels and electroblotted onto BioTrace polyvinylidene difluoride membrane (Pall, Pensacola, FL). After transfer and blocking in 5% nonfat milk cells were probed for P-MAPK and occludin, and then the membranes were stripped and reprobed for MAPK and β -actin, respectively. Super Signal West Pico Chemiluminescent Substrate was used for the immunodetection. The immunoblots were scanned into Adobe Photoshop version 7.0 with a Microtek ScanMaker III scanner. Un-Scan-It version 5.1 for Windows (Silk Scientific) was used to digitize and analyze the relative amounts of protein, based on pixel intensity, in the immunoblot bands.

Immunoprecipitation and immunoblotting. After serum starvation as described in *Cell culture*, HUVEC were treated with EtOH, 10 nM E₂, or 10 nM DHT for 24 h and WCE were prepared as described above. The WCE supernatant was precleared with protein G agarose (Upstate, Charlottesville, VA). Precleared lysate was incubated with rabbit anti-occludin antibody overnight at 4°C and then incubated with protein A Sepharose beads (Zymed, San Francisco, CA) for 2 h at 4°C. After washes in PBS and cell lysis buffer the beads were sedimented, and bound proteins were eluted with Laemmli loading buffer and boiled before separation by SDS-PAGE and Western blotting as described above. Membranes were probed for phosphotyrosine (P-tyr) and then stripped and reprobed for occludin with rabbit anti-occludin antibody (Zymed Laboratories).

Enzyme immunoassay. P-MAPK/MAPK was quantitated with TiterZyme P-ERK1/2 and total ERK1/2 enzyme immunoassay (EIA) kits from Assay Designs (Ann Arbor, MI), and assays were performed according to the manufacturer's instructions. Recombinant P-ERK1/2 and ERK1/2 standards were provided in the kits.

Fixed cell-based 96-well ELISA. Fifteen thousand HUVEC per well were seeded and then fixed on 1% collagen-coated 96-well plates, and ELISA was performed to detect the amount of P-MAPK and occludin expression according to the methods described by Bulayeva et al. (7). P-MAPK and occludin expression were normalized against cell number with the crystal violet staining assay (7).

Paracellular permeability assay. One hundred thousand HUVEC were seeded on polycarbonate porous cell culture inserts/membranes with surface area of 0.33 cm² and a pore size of 0.4 μ m (Corning). To establish a monolayer, HUVEC were grown for 2 days in EGM-2 medium supplemented with 2% FBS. The medium was then changed to EGM-2 supplemented with 2% dextran-coated charcoal-stripped (DCC) serum. After 24-h incubation in DCC serum medium, HUVEC were treated for 24 h with EtOH, 10 nM E₂, or 10 nM DHT. Subsequently, 0.25 μ g/ μ l FITC-labeled Dextran 10 (Sigma) was added to the inner chamber, and the transport of the FITC-dextran across the barrier was determined by measuring the absorbance of the samples taken from the outer chamber at 490 nm over time (19). The apparent permeability coefficient (P_{app}) across the EC barrier was calculated using the equation P_{app} (cm/s) = dQ/dt (ng/min) \times 1/[A (cm²) \times C_o (ng/cm³) \times 60], where dQ/dt is the mass of FITC-dextran transported per minute, A is the surface area of the filter, and C_o is the initial concentration of FITC-dextran used (19). P_{app} values are presented in Table 1.

Transendothelial electrical resistance. EVOM STX2 Chopstick electrodes were purchased from World Precision Instruments (Sarasota, FL). Electrodes were connected to a current source meter (Keithley, Cleveland, OH) and a nanovoltmeter (Keithley) interfaced to a computer to acquire and measure the TEER values as a function of time. One hundred thousand HUVEC were seeded on each insert as described above. Cells were treated with ethanol, 10 nM E₂, or 10 nM

Table 1. Average paracellular permeability coefficient data

Treatment	1 g <i>P</i> _{app}	30 min Post-LO <i>P</i> _{app}	2 h Post-LO <i>P</i> _{app}	4 h Post-LO <i>P</i> _{app}
Filter alone	154±37	216±29	194±14	153±30
Filter with cells	149±31	160±19	173±19	143±31
Ethanol	114±29	183±45	171±34	133±24
10 nM E ₂	67±11	126±12	170±22	140±23
10 nM DHT	100±30	137±16	130±7	158±24

Apparent permeability coefficient (*P*_{app}) values (in cm/s × 10⁻⁶) are averages ± SE for *n* = 3–9 experiments. Human umbilical vein endothelial cells were plated on cell culture inserts. After 24-h serum and growth factor starvation, the cells were treated with ethanol, 10 nM 17β-estradiol (E₂), or 10 nM dihydrotestosterone (DHT) for 24 h. The inserts (with cells) were either kept at 1 g or subjected to the liftoff (LO) hypergravity profile in the NASA flight simulator as described in MATERIALS AND METHODS. After LO, the cells were returned to the CO₂ incubator at 1 g for the indicated post-LO recovery times. Paracellular permeability was measured with FITC-labeled dextran and *P*_{app} calculated as described in MATERIALS AND METHODS.

DHT for 24 h as described above. Where indicated, cells were also pretreated with either estrogen receptor (ER)-α antibody HC20 or ER-β antibody H150 (both from Santa Cruz) or androgen receptor (AR) antibody (catalog no. 3202, Cell Signaling) for 30 min before the addition of hormone to evaluate antibody hindrance of the activation of plasma membrane-associated ER or AR. TEER was measured by placing one of the EVOM STX2 Chopstick electrodes on either side of the cell culture insert and applying a 10-μA current across the EC monolayer. TEER values across the EC barrier were measured every 6 s for 5 min, i.e., 50 values, and averaged to determine the TEER value. The experiment was repeated three times to obtain a final time-averaged TEER value across the EC barrier for each treatment condition; these data were then normalized to the time-averaged TEER values obtained for the filter control. The TEER measurements across filters without HUVEC were set to 100% and used as the control for normalizing values obtained for HUVEC in medium, EtOH, 10 nM E₂, and 10 nM DHT.

Complex IV/cytochrome-c oxidase activity assay. Cytochrome-c oxidase (COX) activity was determined with a COX microplate assay (MS421) from MitoSciences (Eugene, OR) according to the manufacturer's protocol. Briefly, 6,000 cells were plated per well in six-well plates. Twenty-four hours after plating, the cells were treated with ethanol, 10 nM E₂, or 10 nM DHT for 24 h in serum- and GF-free EBM-2 medium. After LO hypergravity as described above and in Fig. 1–6, selected plates were returned to the incubator for 30 min, 2 h, and 4 h. At the time indicated in Fig. 5, WCE were prepared in the solutions provided in the COX assay kit according to the manufacturer's protocol. After determination of the protein concentrations, 20 μg of WCE in a total volume of 200 μl was added in quadruplicate to the 96-well microplate and the COX enzyme was immunocaptured within the wells. COX activity was measured colorimetrically as a change in the absorbance at 550 nm over time (0–105 min) with a plate reader (Biotech Instruments, Winooski, VT). The average ± SD of the quadruplicate values for each time point and treatment group were graphed, and the rate of COX activity was determined by the initial slope, i.e., values in the linear range from 20 to 50 min, expressed as change in optical density per minute.

RESULTS

E₂ and DHT partially restore suppressed MAPK activity after LO hypergravity. It was recently reported that E₂ and DHT rapidly, i.e., within 5 min, activate MAPK in HUVEC at 1 g in a receptor-dependent manner (44). However, subjecting HUVEC to a 7.5-min LO hypergravity profile mimicking that experienced by astronauts in the space shuttle decreased

MAPK activity to below basal levels (1 g) and prevented E₂ and DHT from activating MAPK phosphorylation immediately after exposure to LO hypergravity (44). Here we examined the time needed after LO hypergravity for recovery of MAPK activation at 1 g. As shown in Fig. 1, cotreatment with the ER and AR antagonists ICI-182780 and bicalutamide, respectively, inhibited E₂- and DHT-increased MAPK activation at 1 g. Likewise, preincubation with the MEK inhibitor PD-98059 inhibited MAPK activation by E₂ and DHT, indicating non-genomic activation of MAPK in HUVEC. Notably, MAPK activation was suppressed after LO. Twenty-four-hour pretreatment with E₂ or DHT did not protect the cells against the LO-mediated suppression of MAPK activity. However, when the cells were restored to 1 g after LO, the P-MAPK-to-MAPK ratio was increased by E₂ at the 1, 2, and 4 h time points. In contrast, DHT induced an increase in MAPK phosphorylation only at the 4 h time point, indicating a delayed MAPK activation response.

Changes in occludin expression over time after LO. Twenty-four-hour treatment of HUVEC with E₂ and DHT increased occludin mRNA and protein expression at 1 g, and LO did not alter this hormone-mediated increase (44). Here we examined whether occludin expression changes over time after LO when cells are returned to 1 g and whether E₂ or DHT affects this response. As seen in Fig. 2, when HUVEC were subjected to LO hypergravity and then incubated at 1 g, E₂-treated cells showed decreased occludin 10 min after LO. In contrast, DHT-treated HUVEC maintained increased occludin levels up to 2 h after LO.

E₂ and DHT enhance EC TJ function by decreasing paracellular permeability and increasing TEER at 1 g. Because E₂ and DHT increased occludin protein expression in HUVEC, a goal of this study was to investigate whether E₂ or DHT alters EC TJ barrier function as measured by TEER and paracellular permeability. An increase in TEER (Fig. 3) and a decrease in paracellular permeability (Fig. 4) were observed when HUVEC were plated on the filter in medium alone. The magnitude of the increase in TEER was comparable with

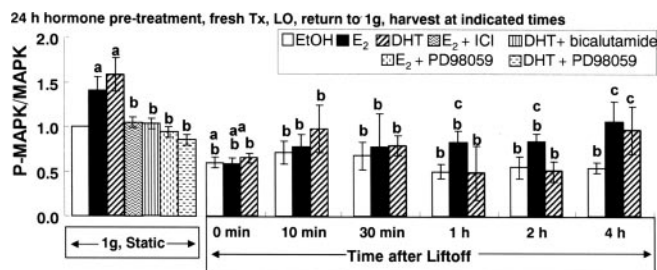

Fig. 1. Differential recovery of suppressed MAPK in human umbilical vein endothelial cells (HUVEC) by 17β-estradiol (E₂) and DHT. HUVEC were pretreated for 24 h with EtOH, 10 nM E₂, 10 nM DHT, 10 nM E₂ + 100 nM ICI-182780, or 10 nM DHT + 100 nM bicalutamide (1 g, static). For the indicated samples, HUVEC were pretreated with 10 μM PD-98059 for 2 h before addition of 10 nM E₂ or 10 nM DHT for 24 h. Some cells were then subjected to liftoff (LO) simulation (see MATERIALS AND METHODS) in medium with a fresh dose of EtOH, E₂, or DHT. After LO, the cells were placed in a tissue culture incubator at 1 g and harvested at the indicated time points. The phospho (P)-MAPK-to-MAPK ratio was determined by enzyme immunoassay as described in MATERIALS AND METHODS. ^aSignificantly different from EtOH 1 g control (*P* < 0.05); ^bsignificantly different from identical treatment at 1 g without LO (*P* < 0.05); ^csignificantly different from EtOH within that time point (*P* < 0.05). Tx, treatment.

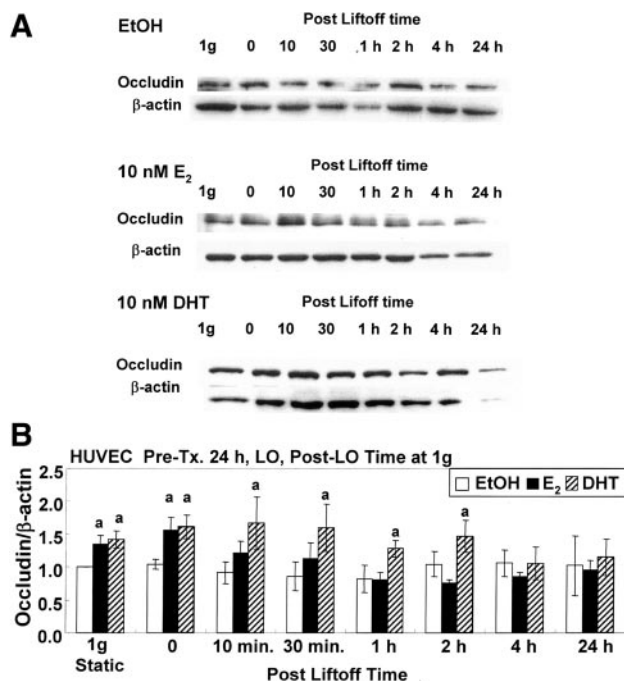

Fig. 2. Effect of post-LO time on occludin expression. HUVEC were pretreated for 24 h with EtOH, 10 nM E₂, or 10 nM DHT (1 g, static). Some cells were then subjected to LO simulation (see MATERIALS AND METHODS), allowed to recover as described in Fig. 1, and harvested at the indicated time points. Occludin expression was determined by Western blot. The same blots were stripped and reprobed with β -actin for normalization as described in MATERIALS AND METHODS. A: Western blots representing 1 single experiment. B: data are a summary of occludin/ β -actin expression. Values are means \pm SE; $n = 3-6$. *Significantly different from EtOH 1 g control ($P < 0.05$).

previous findings in brain capillaries (46). In addition, Seebach et al. (41) reported that TEER values of confluent EC monolayers can range from 3 to 1,000 $\Omega \cdot \text{cm}^2$ depending on EC type and physiological conditions. Monolayers of brain capillary endothelial cells have been reported to have TEER of $\sim 100-150 \Omega \cdot \text{cm}^2$ in the presence of serum (23). However, Huang et al. (24) demonstrated TEER values between 6 and 12 $\Omega \cdot \text{cm}^2$ in HUVEC monolayers, while Hurst and Fritz reported TEER values of $\sim 20-40 \Omega \cdot \text{cm}^2$ for immortalized HUVEC (25). Treatment of HUVEC with E₂ and DHT increased TEER compared with medium or EtOH, indicating that both hormones increase EC barrier function (Fig. 3). Preincubation of HUVEC with antibodies to ER- α , ER- β , and AR inhibited the respective ligand-induced increase in TEER, suggesting that the plasma membrane-associated receptors may mediate the observed ligand-respective increase in TEER.

Next, the effect of E₂ and DHT on EC barrier function was determined over time after LO hypergravity. LO did not alter paracellular permeability. Importantly, treatment with either E₂ or DHT resulted in a significant decrease in paracellular permeability assayed 30 min after LO (Fig. 4B). However, after 2 h of recovery at 1 g, only DHT-treated cells showed a significant decrease in P_{app} (Fig. 4C). When assayed at 4 h after LO, the paracellular permeabilities of the E₂- and DHT-treated cells were equivalent to those of the EtOH-treated cells, indicating a loss of the protective EC barrier function of both hormones (Fig. 4D).

Effect of LO hypergravity on COX activity. Since ATP is needed to maintain EC barrier function (26) and mitochondrial

respiration is the primary source of cellular ATP, the effect of hypergravity and E₂ or DHT on complex IV, i.e., COX activity, was examined in HUVEC pretreated for 24 h with EtOH, E₂, or DHT (Fig. 5). EtOH did not affect COX activity in HUVEC (relative to medium alone); however, both E₂ and DHT inhibited COX activity compared with the EtOH control. Immediately after HUVEC were subjected to LO hypergravity, COX activity was decreased in the E₂-treated cells, whereas DHT-treated cells showed increased COX activity. There was no significant change in COX activity after 30 min following LO. After 2 h of recovery at 1 g following LO COX activity in the EtOH-treated cells was significantly reduced, and a further decrease was seen 4 h after LO. Similarly, the DHT-treated cells showed reduced COX activity at 2 h but no further decline 4 h after LO. The E₂-treated cells showed no change in COX activity until 4 h after LO.

E₂ and DHT differentially enhance occludin phosphorylation on tyrosine residues. Since P-occludin modulates paracellular permeability and occludin is phosphorylated via the MAPK pathway (28, 49), we measured the effect of LO on P-tyr-occludin by immunoprecipitation for occludin and Western blotting for P-tyr and total occludin. P-tyr-occludin expression was compared with MAPK activation (Fig. 6A). After 24 h at 1 g, both E₂ and DHT increased the P-tyr-occludin-to-total

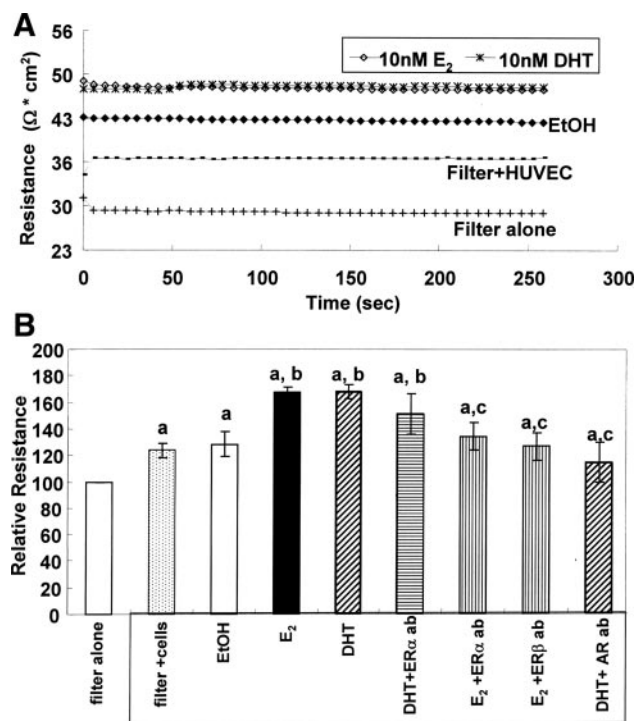

Fig. 3. E₂ and DHT increase transendothelial electrical resistance (TEER). HUVEC were seeded on Transwell inserts and treated as indicated and as described in MATERIALS AND METHODS. TEER was measured across the EC barrier as described in MATERIALS AND METHODS. A: 1 representative TEER experiment. TEER was measured every 6 s for ~ 250 s. B: once resistance was stabilized, the TEER value of the filter was set to 100% for normalization. Where indicated, cells were pretreated with estrogen receptor (ER)- α antibody HC20, ER- β antibody H150, or androgen receptor (AR) antibody for 30 min before addition of the treatment. Values are means \pm SE; $n = 3$. *Significantly different from filter without HUVEC ($P < 0.05$); ^bsignificantly different from EtOH control ($P < 0.05$); ^csignificantly different from identical treatment without antibody ($P < 0.05$).

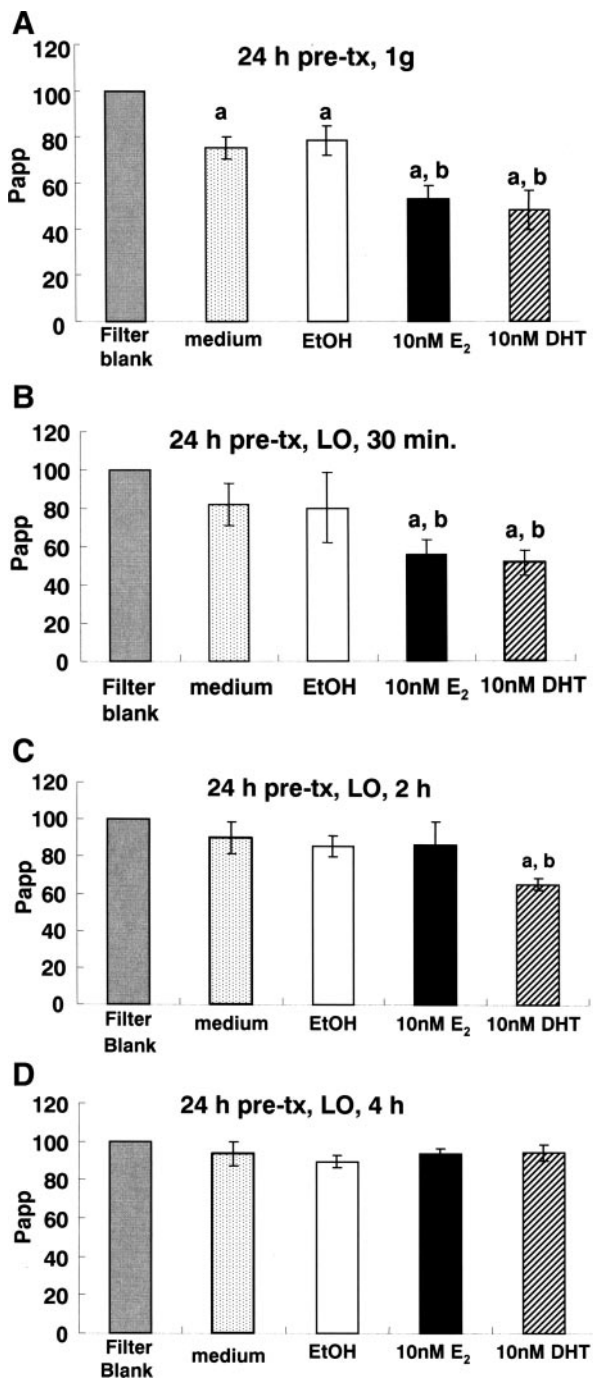

Fig. 4. E₂ and DHT differentially affect paracellular permeability over time after LO. HUVEC were seeded on Transwell inserts, treated for 24 h as indicated, and subjected to LO hypergravity as described in MATERIALS AND METHODS. After LO, the cells were placed back into the incubator for the time indicated. Paracellular permeability was measured with FITC-labeled Dextran 10 at 1 g (A) and 30 min (B), 2 h (C), and 4 h (D) after LO. The apparent permeability coefficient (P_{app}) value for the filter without cells was taken as 100%, and other values were normalized against it. Values are means \pm SE; $n = 3-4$. ^aSignificantly different from filter alone (without cells) control ($P < 0.01$); ^bsignificantly different from EtOH ($P < 0.01$).

occludin ratio (Fig. 6B). LO hypergravity did not significantly alter the P-tyr-occludin-to-total occludin ratio (data not shown). After 30 min of recovery at 1 g after LO, P-tyr-occludin/total occludin was reduced to basal levels in both E₂-

and DHT-treated samples (Fig. 6B). However, 2 h after LO there was an increase in P-tyr-occludin/total occludin in hormone-treated cells, and this increase was maintained at the 4 h post-LO time point (Fig. 6B).

DISCUSSION

POI is perhaps the most prevalent and potentially life-threatening cardiovascular problem related to spaceflight, with the hypergravity experienced by astronauts during liftoff into space being identified as a possible mechanism for impaired vascular function impairment. Potential contributors to the problem may include, but are not limited to, reduced plasma volume (32), inadequate peripheral resistance response (6), and intravascular fluid shifting (36). These alterations in fluid transport have been attributed to changes in capillary transport (5, 33). The role of EC in regulating fluid transport at the capillary level via EC permeability pathways has been reported (11, 13, 21, 22, 38, 40, 45). Here HUVEC were subjected to hypergravity by exactly mimicking the LO profile of the NASA space shuttle. Since astronauts experience the same hypergravity as the space shuttle vehicle, EC in vivo would sense the same gravitational force as the astronaut's body, with the effect being experienced immediately (within seconds) after exposure to the altered gravitational force (35, 36). This study examined whether the deleterious effects of LO hypergravity on MAPK activity and TJ function could be reversed

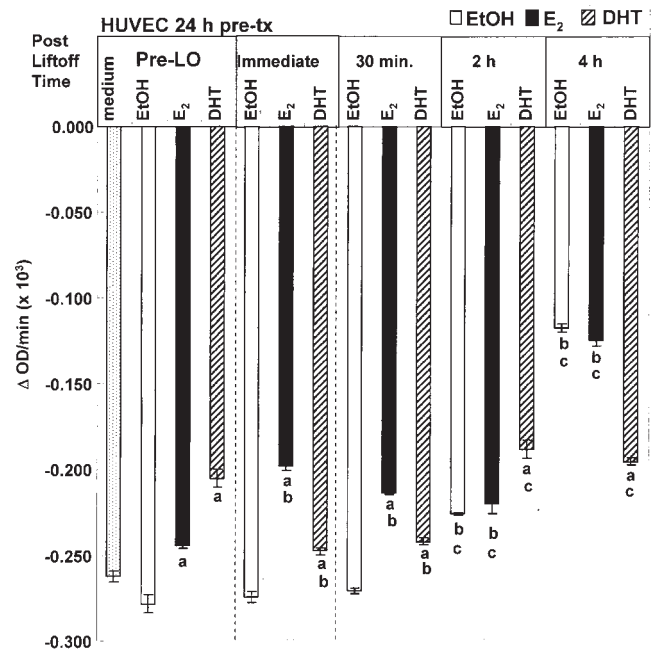

Fig. 5. Effect of E₂ and DHT on cytochrome-c oxidase (COX) activity over time after LO. HUVEC were treated with medium, EtOH, 10 nM E₂, or 10 nM DHT for 24 h. As indicated, selected cells were subjected to 3 g LO hypergravity for 5 min. After LO, the indicated cells were immediately harvested (Immediate), and other cells were allowed to recover for the indicated times (30 min, 2 or 4 h) at 1 g in the tissue culture incubator. COX activity was measured as described in MATERIALS AND METHODS. Values are rates of COX activity [expressed as change in optical density (ΔOD)/min] and are means \pm SD; $n = 4$. ^aSignificantly different from EtOH control within that time point/data set ($P < 0.05$); ^bsignificantly different from same treatment before LO ($P < 0.05$); ^csignificantly different from same treatment immediately after LO ($P < 0.05$).

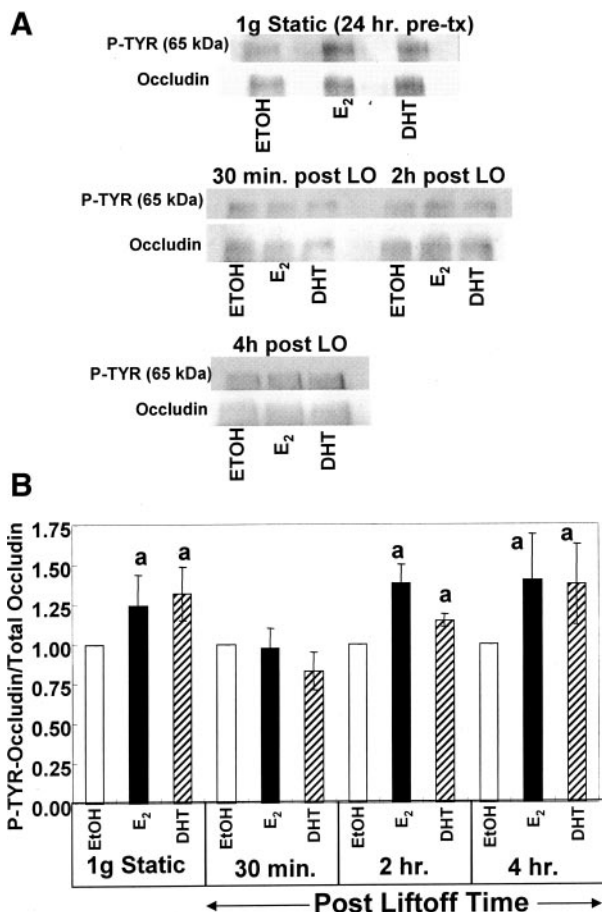

Fig. 6. E₂ and DHT alter the phosphotyrosine (P-tyr)-occludin-to-occludin ratio in HUVEC. HUVEC were serum starved for 24 h and treated with EtOH, 10 nM E₂, or 10 nM DHT for 24 h. After treatment, cells were either kept at 1 g or subjected to LO as described in MATERIALS AND METHODS. After LO, cells were placed in the tissue culture incubator for the indicated recovery times. Immunoprecipitation for occludin and immunoblotting for P-tyr and then occludin was performed and analyzed as described in MATERIALS AND METHODS. A: representative Western blots. B: mean \pm SE P-tyr occludin/total occludin values; $n = 3$. ^aSignificantly different from EtOH 1 g control ($P < 0.05$); ^bsignificantly different from identical treatment at 1 g without LO ($P < 0.05$); ^csignificantly different from EtOH within that time point ($P < 0.05$).

by “postflight” recovery at 1 g. Because of the noted sex difference in POI, i.e., female astronauts have a higher incidence of POI than males (50), and the established vasoprotective effects of estrogens (reviewed in Refs. 8, 20, 29), the effects of the hormones E₂ and DHT were examined in this cell model. Although it would be of interest to evaluate the response of EC from females versus males, the effect of sex was not investigated in this study.

The data presented demonstrate three important conclusions. First, although both E₂ and DHT increased occludin expression in HUVEC at 1 g and LO had no immediate effect on occludin levels (44), occludin expression declines over time after LO at 1 g. Second, this decrease in occludin correlates with an increase in paracellular permeability measured by two different assays. This decrease in EC TJ barrier function could lead to a decrease in vascular volume and an increase in extracellular fluid as reported in astronauts after spaceflight (2), which may result in POI. Third, the higher incidence of POI in female astronauts (50) corresponds to a longer “protective” effect of

DHT versus E₂ on maintaining occludin expression, maintaining COX activity, and inhibiting paracellular permeability observed here in HUVEC. This is the first study to demonstrate a correlation between TEER, paracellular permeability, occludin levels, MAPK activation, COX activity, and E₂ or DHT activity. Since different vascular beds differ in function, further studies using adult EC from other vascular beds are required to evaluate the true translational applicability of the present study. A limitation of our study is that HUVEC were grown in FBS derived from animals of unknown sex and thus containing unknown amounts of GF and hormones before the 24-h serum starvation required before the treatments used in this study, which were added to the medium in the absence of FBS.

Interestingly, there was a separation of the effects of E₂ and DHT on MAPK activation, COX activity, occludin expression, and paracellular permeability over time after LO (Fig. 7). As shown here, 24-h pretreatment of HUVEC with E₂ or DHT at 1 g increased MAPK activation. LO decreased MAPK activation. Although MAPK activity remained suppressed in DHT-treated HUVEC for 2 h after LO, E₂ increased MAPK activation after 1 h. This increase in P-MAPK/MAPK correlates with the increased P-occludin-to-total occludin ratio. In turn, these data correlate with a decrease in total occludin and increased paracellular permeability. Thus these data suggest a possible mechanism by which E₂ contributes to decreased EC barrier function at 2 h after LO.

In contrast, DHT-treated HUVEC showed a longer protection of EC barrier function that correlates with increased total occludin up to 2 h after LO. The exact reason for the differential effects of E₂ and DHT and the decrease of hormone-mediated EC barrier protection over time is currently unknown. However, in light of previous reports that ER and AR subcellular distribution impacts their nongenomic activity (3, 42), we speculate that the subcellular distribution of membrane-associated versus nuclear ER and AR in HUVEC may regulate MAPK activity, and thus occludin phosphorylation.

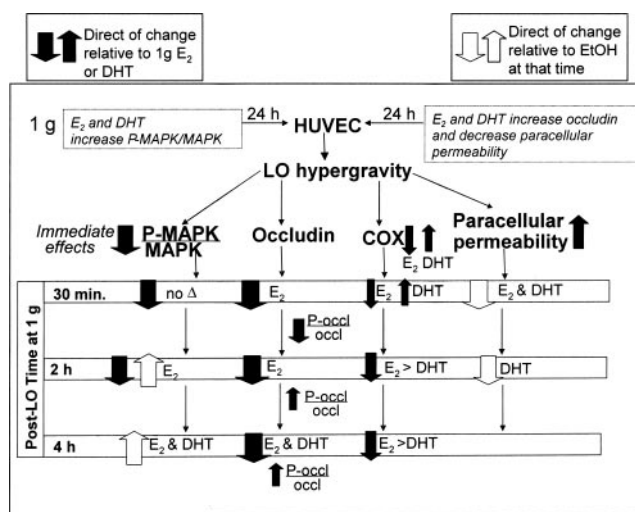

Fig. 7. Model of effect of hypergravity on HUVEC and impact of E₂ and DHT on post-LO recovery at 1 g. The model is a summary of the data presented in Figs. 1–6. Filled arrows indicate the direction of observed changes with E₂ and DHT relative to before LO. Open arrows indicate changes relative to EtOH vehicle control at that time point. Noteworthy is the apparent correlation of P-MAPK/MAPK with P-tyr-occludin-to-total occludin ratio (P-occl/occl; Fig. 6) and changes in paracellular permeability.

Indeed, the observation in this study that ER- α , ER- β , and AR antibodies inhibited ligand-specific increases in TEER is in concordance with membrane localization and activity of these receptors. When measured at 4 h after LO, both E₂- and DHT-treated HUVEC exhibited partial recovery of MAPK activity, which supports the hypothesis that the P-occludin-to-total occludin ratio would increase, resulting in increased paracellular permeability. As expected, the P-tyr-occludin-to-total occludin ratio was increased in E₂- and DHT-treated cells 4 h after LO.

Our data are in agreement with reports that E₂ decreased paracellular permeability and increased occludin expression in EC (51). However, our data disagree with a report that E₂ decreased TJ resistance and increased paracellular permeability in cervical epithelial cells (52). Together, these reports and our data indicate that the effects of E₂ on occludin expression and TJ function are cell type specific.

Gravity plays an important role in maintaining fluid volume in the vasculature (reviewed in Ref. 2). During spaceflight, astronauts experience hypergravity up to 3 g during LO from Earth, followed by microgravity in space and then a return to 1 g back on Earth. These gravity changes result in a reduction of plasma volume, possibly through disruption of TJ function in EC, which may contribute to the POI observed in astronauts. Our study supports a role of both E₂ and DHT in maintaining the TJ function in HUVEC exposed to LO hypergravity and indicates that DHT has a longer protective effect than E₂ on decreasing paracellular permeability. The correlation of these in vitro data to the lower incidence of POI in male astronauts (50) warrants further investigation. One caveat of our study is that HUVEC are from a conduit fetal vessel; thus the conclusions reached here require further testing to be applicable to adult microvascular beds since different vascular beds differ in functional and morphological characteristics (10), and it is possible that the present results are unique to HUVEC.

The mechanisms by which hypergravity impacts EC responses are largely unknown. Long-term EC responses to 3 g hypergravity include increased caveolin-1 gene transcription (43). E₂ was reported to stimulate *cav-1* transcription in EC (37), but no one has examined the effect of androgens on *cav-1* expression or EC function. Activation of *cav-1* leads to the activation of many signaling pathways including MAPK (43) and PI3K (4) that maintain vascular tone and EC barrier function (43). It is interesting to note that ER- α interacts directly with *cav-1* (1), which offers a possible mechanism of cross talk between E₂, hypergravity, and TJ function.

There are few reports connecting hypergravity with mitochondrial respiration and EC barrier enhancement. One study reported that subjecting rats to 3.1 g hypergravity for 8 mo increased basal metabolism and reduced the number, but increased the size, of mitochondria in the heart (17). In EC, ATP production via mitochondrial respiration was reported to enhance EC barrier properties (26, 34). Here we observed that 24-h treatment of HUVEC with either E₂ or DHT inhibited COX activity by 12% or 25%, respectively, which would indicate a decrease in mitochondrial respiration and ATP production. The effect of E₂ on COX activity could be genomic since E₂ was reported to inhibit the transcription of COX subunit I ~30% in human periodontal ligament cells (27). In contrast, DHT had no effect on COX subunit I mRNA in rat Sertoli cells (31). The effect of DHT may be cell type specific

since 2 wk of testosterone treatment of exercise-trained female rats increased COX activity in the heart and soleus and extensor digitorum longus muscles (48). Immediately after HUVEC were subjected to LO hypergravity, E₂-treated cells showed decreased COX activity, whereas DHT-treated cells had increased COX activity that was sustained until 2 h after LO. Thus there was a time-dependent separation of the effect of E₂ and DHT on COX activity after LO, with DHT maintaining COX activity longer, i.e., up to 4 h, compared with E₂. This observation correlates with the more sustained maintenance of EC TJ barrier function as measured by decreased P_{app} in HUVEC treated with DHT. These data correlate with the observed lower incidence of POI in male astronauts (50), although further studies are needed to refine this pathway and to elucidate the effects of hormones on EC barrier function under hypergravity conditions.

ACKNOWLEDGMENTS

We thank Lei Zhao for her contributions to the experiments reported in this manuscript.

GRANTS

Supported by NASA Grant NAG5-12874 to C. M. Klinge and R. S. Keynton and by American Heart Association Ohio Valley Affiliate Grant 0555270B to C. M. Klinge. W. K. Sumanasekera was supported by American Heart Association Ohio Valley Affiliate Postdoctoral Fellowship 0425431B.

REFERENCES

1. **Acconcia F, Ascenzi P, Bocedi A, Spisni E, Tomasi V, Trentalance A, Visca P, Marino M.** Palmitoylation-dependent estrogen receptor α membrane localization: regulation by 17 β -estradiol. *Mol Biol Cell* 16: 231–237, 2005.
2. **Baisch JF, Wolfram G, Beck L, Drummer C, Stormer I, Buckley J, Blomqvist G.** Orthostatic stress is necessary to maintain the dynamic range of cardiovascular control in space. *Pflügers Arch* 441: R52–R61, 2000.
3. **Barletta F, Wong CW, McNally C, Komm BS, Katzenellenbogen B, Cheskis BJ.** Characterization of the interactions of estrogen receptor and MNAR in the activation of cSrc. *Mol Endocrinol* 18: 1096–1108, 2004.
4. **Baron S, Manin M, Beaudoin C, Leotoing L, Communal Y, Veysié G, Morel L.** Androgen receptor mediates non-genomic activation of phosphatidylinositol 3-OH kinase in androgen-sensitive epithelial cells. *J Biol Chem* 279: 14579–14586, 2004.
5. **Blomqvist CG, Buckley JC, Gaffney FA, Lane LD, Levine BD, Watenpaugh DE.** Mechanisms of post-flight orthostatic intolerance. *J Gravit Physiol* 1: P122–P124, 1994.
6. **Buckley JC, Lane LD, Levine BD, Watenpaugh DE, Wright SJ, Moore WE, Gaffney FA, Blomqvist CG.** Orthostatic intolerance after spaceflight. *J Appl Physiol* 81: 7–18, 1996.
7. **Bulayeva NN, Gametchu B, Watson CS.** Quantitative measurement of estrogen-induced ERK 1 and 2 activation via multiple membrane-initiated signaling pathways. *Steroids* 69: 181–192, 2004.
8. **Chambliss KL, Shaul PW.** Estrogen modulation of endothelial nitric oxide synthase. *Endocr Rev* 23: 665–686, 2002.
9. **Chen YH, Lu Q, Goodenough DA, Jeanson B.** Nonreceptor tyrosine kinase c-Yes interacts with occludin during tight junction formation in canine kidney epithelial cells. *Mol Biol Cell* 13: 1227–1237, 2002.
10. **Cho MM, Ziats NP, Abdul-Karim FW, Pal D, Goldfarb J, Utian WH, Gorodeski GI.** Effects of estrogen on tight junctional resistance in cultured human umbilical vein endothelial cells. *J Soc Gynecol Investig* 5: 260–270, 1998.
11. **Citi S.** The molecular organization of tight junctions. *J Cell Biol* 121: 485–489, 1993.
12. **Convertino VA.** G-factor as a tool in basic research: mechanisms of orthostatic tolerance. *J Gravit Physiol* 6: P73–P76, 1999.
13. **Dejana E.** Endothelial adherens junctions: implications in the control of vascular permeability and angiogenesis. *J Clin Invest* 98: 1949–1953, 1996.

14. **Drummer C, Gerzer R, Baisch F, Heer M.** Body fluid regulation in micro-gravity differs from that on Earth: an overview. *Pflügers Arch* 441: R66–R72, 2000.
15. **Drummer C, Heer M, Joosten M, Stormer I, Hesse C, Beck L, Wolfram G, Baisch F.** Regulation and distribution of body fluid during a 6-day head-down tilt study in a randomized cross-over design. *J Gravit Physiol* 7: P187–P188, 2000.
16. **Drummer C, Hesse C, Baisch F, Norsk P, Elmann-Larsen B, Gerzer R, Heer M.** Water and sodium balances and their relation to body mass changes in microgravity. *Eur J Clin Invest* 30: 1066–1075, 2000.
17. **Economos AC, Miquel J, Ballard RC, Blunden M, Lindseth KA, Fleming J, Philpott DE, Oyama J.** Effects of simulated increased gravity on the rate of aging of rats: implications for the rate of living theory of aging. *Arch Gerontol Geriatr* 1: 349–363, 1982.
18. **Farshori P, Kachar B.** Redistribution and phosphorylation of occludin during opening and resealing of tight junctions in cultured epithelial cells. *J Membr Biol* 170: 147–156, 1999.
19. **Fletcher NF, Brayden DJ, Brankin B, Worrall S, Callanan JJ.** Growth and characterisation of a cell culture model of the feline blood-brain barrier. *Vet Immunol Immunopathol* 109: 233–244, 2006.
20. **Gray GA, Sharif I, Webb DJ, Seckl JR.** Oestrogen and the cardiovascular system: the good, the bad and the puzzling. *Trends Pharmacol Sci* 22: 152–156, 2001.
21. **Gumbiner B.** Structure, biochemistry, and assembly of epithelial tight junctions. *Am J Physiol Cell Physiol* 253: C749–C758, 1987.
22. **Hirase T, Staddon JM, Saitou M, Ando-Akatsuka Y, Itoh M, Furuse M, Fujimoto K, Tsukita S, Rubin LL.** Occludin as a possible determinant of tight junction permeability in endothelial cells. *J Cell Sci* 110: 1603–1613, 1997.
23. **Hoheisel D, Nitz T, Franke H, Wegener J, Hakvoort A, Tilling T, Galla HJ.** Hydrocortisone reinforces the blood-brain properties in a serum free cell culture system. *Biochem Biophys Res Commun* 247: 312–315, 1998.
24. **Huang AJ, Furie MB, Nicholson SC, Fischberg J, Liebovitch LS, Silverstein SC.** Effects of human neutrophil chemotaxis across human endothelial cell monolayers on the permeability of these monolayers to ions and macromolecules. *J Cell Physiol* 135: 355–366, 1988.
25. **Hurst RD, Fritz IB.** Properties of an immortalised vascular endothelial/glioma cell co-culture model of the blood-brain barrier. *J Cell Physiol* 167: 81–88, 1996.
26. **Jacobson JR, Dudek SM, Singleton PA, Kolosova IA, Verin AD, Garcia JG.** Endothelial cell barrier enhancement by ATP is mediated by the small GTPase Rac and cortactin. *Am J Physiol Lung Cell Mol Physiol* 291: L289–L295, 2006.
27. **Jonsson D, Nilsson J, Odenlund M, Bratthall G, Broman J, Ekblad E, Lydrup ML, Nilsson BO.** Demonstration of mitochondrial oestrogen receptor β and oestrogen-induced attenuation of cytochrome *c* oxidase subunit I expression in human periodontal ligament cells. *Arch Oral Biol* 52: 669–676, 2007.
28. **Kevil CG, Oshima T, Alexander B, Coe LL, Alexander JS.** H₂O₂-mediated permeability: role of MAPK and occludin. *Am J Physiol Cell Physiol* 279: C21–C30, 2000.
29. **Klinge CM, Bambara RA, Hilf R.** What differentiates antiestrogen-liganded vs. estradiol-liganded estrogen receptor action? *Oncol Res* 4: 137–144, 1992.
30. **Klinge CM, Blankenship KA, Risinger KE, Bhatnagar S, Noisin EL, Sumanasekera WK, Zhao L, Brey DM, Keynton RS.** Resveratrol and estradiol rapidly activate MAPK signaling through estrogen receptors alpha and beta in endothelial cells. *J Biol Chem* 280: 7460–7468, 2005.
31. **Ku CY, Lu Q, Ussuf KK, Weinstock GM, Sanborn BM.** Hormonal regulation of cytochrome oxidase subunit messenger RNAs in rat Sertoli cells. *Mol Endocrinol* 5: 1669–1676, 1991.
32. **Leach CS, Alfrey CP, Suki WN, Leonard JI, Rambaut PC, Inners LD, Smith SM, Lane HW, Krauhs JM.** Regulation of body fluid compartments during short-term spaceflight. *J Appl Physiol* 81: 105–116, 1996.
33. **Louisy F, Andre-Deshays C, Cauquil D, Lazerges M, Lafaye C, Camus AL, Schroiff P, Gallina G.** Air plethysmography: an alternative method for assessing peripheral circulatory adaptations during space-flights. *Eur J Appl Physiol* 85: 383–391, 2001.
34. **Motte S, Communi D, Piroton S, Boeynaems JM.** Involvement of multiple receptors in the actions of extracellular ATP: the example of vascular endothelial cells. *Int J Biochem Cell Biol* 27: 1–7, 1995.
35. **Pantalos GM, Bennett TE, Sharp MK, Woodruff SJ, O'Leary DS, Gillars KJ, Schurfranz T, Everett SD, Lemon M, Schwartz J.** The effect of gravitational acceleration on cardiac diastolic function: a biofluid mechanical perspective with initial results. *Curr Pharm Biotechnol* 6: 331–341, 2005.
36. **Pantalos GM, Sharp MK, Woodruff SJ, O'Leary DS, Lorange R, Everett SD, Bennett TE, Schurfranz T.** Influence of gravity on cardiac performance. *Ann Biomed Eng* 26: 931–943, 1998.
37. **Razandi M, Oh P, Pedram A, Schnitzer J, Levin ER.** ERs associate with and regulate the production of caveolin: implications for signaling and cellular actions. *Mol Endocrinol* 16: 100–115, 2002.
38. **Rubin LL.** Endothelial cells: adhesion and tight junctions. *Curr Opin Cell Biol* 4: 830–833, 1992.
39. **Sakakibara A, Furuse M, Saitou M, Ando-Akatsuka Y, Tsukita S.** Possible involvement of phosphorylation of occludin in tight junction formation. *J Cell Biol* 137: 1393–1401, 1997.
40. **Schneeberger EE, Lynch RD.** Structure, function, and regulation of cellular tight junctions. *Am J Physiol Lung Cell Mol Physiol* 262: L647–L661, 1992.
41. **Seebach J, Dieterich P, Luo F, Schillers H, Vestweber D, Oberleithner H, Galla HJ, Schnittler HJ.** Endothelial barrier function under laminar fluid shear stress. *Lab Invest* 80: 1819–1831, 2000.
42. **Song RX, Fan P, Yue W, Chen Y, Santen RJ.** Role of receptor complexes in the extranuclear actions of estrogen receptor α in breast cancer. *Endocr Relat Cancer* 13: S3–S13, 2006.
43. **Spisni E, Bianco MC, Griffoni C, Toni M, D'Angelo R, Santi S, Riccio M, Tomasi V.** Mechanosensing role of caveolae and caveolar constituents in human endothelial cells. *J Cell Physiol* 197: 198–204, 2003.
44. **Sumanasekera WK, Zhao L, Ivanova M, Morgan DD, Noisin EL, Keynton RS, Klinge CM.** Effect of estradiol and dihydrotestosterone on hypergravity-induced MAPK signaling and occludin expression in human umbilical vein endothelial cells. *Cell Tissue Res* 324: 243–253, 2006.
45. **Tarbell JM, DeMaio L, Zaw MM.** Effect of pressure on hydraulic conductivity of endothelial monolayers: role of endothelial cleft shear stress. *J Appl Physiol* 87: 261–268, 1999.
46. **Tretiaeh M, van Driel D, Gillies MC.** Transendothelial electrical resistance of bovine retinal capillary endothelial cells is influenced by cell growth patterns: an ultrastructural study. *Clin Exp Ophthalmol* 31: 348–353, 2003.
47. **Tsukamoto T, Nigam SK.** Role of tyrosine phosphorylation in the reassembly of occludin and other tight junction proteins. *Am J Physiol Renal Physiol* 276: F737–F750, 1999.
48. **van Breda E, Keizer HA, Vork MM, Surtel DA, de Jong YF, van der Vusse GJ, Glatz JF.** Modulation of fatty-acid-binding protein content of rat heart and skeletal muscle by endurance training and testosterone treatment. *Pflügers Arch* 421: 274–279, 1992.
49. **Wang Y, Zhang J, Yi XJ, Yu FS.** Activation of ERK1/2 MAP kinase pathway induces tight junction disruption in human corneal epithelial cells. *Exp Eye Res* 78: 125–136, 2004.
50. **Waters WW, Ziegler MG, Meck JV.** Postspaceflight orthostatic hypotension occurs mostly in women and is predicted by low vascular resistance. *J Appl Physiol* 92: 586–594, 2002.
51. **Ye L, Martin TA, Parr C, Harrison GM, Mansel RE, Jiang WG.** Biphasic effects of 17-beta-estradiol on expression of occludin and trans-endothelial resistance and paracellular permeability in human vascular endothelial cells. *J Cell Physiol* 196: 362–369, 2003.
52. **Zeng R, Li X, Gorodeski GI.** Estrogen abrogates transcervical tight junctional resistance by acceleration of occludin modulation. *J Clin Endocrinol Metab* 89: 5145–5155, 2004.